



ROPOX Toilet lifter Electric



User manual

This manual should always be in close proximity of the product

Table of content

1. Symbols used in this manual	3
2. General safety	3
2.1 Product Unit label	5
3. General requirements	6
3.1 Product information	6
3.2 Product description	7
3.3 Intended use.....	7
3.4 Intended operator	7
3.5 Essential performance	7
3.6 Non-clinical functions	7
3.7 Clinical functions	7
3.8 Product dimensions.....	7
4. Instructions for use	8
4.1 Installation of product.....	8
4.1.1 Installation interface for water and electrical socket	8
4.1.2 Installation interface for floor drain	8
4.1.3 Installation interface for wall drain	9
4.1.4 Construction.....	10
4.1.5 Mounting the product	11
4.1.6 Pair the Bluetooth remote	14
4.1.7 Unlock the handcontrol	14
4.1.5 ... continued.....	15
4.2 Operating the product	18
4.3 Residual risks.....	18
4.4 Installation of accessories.....	19
4.4.1 Installation of height adjustable toilet support arms.....	19
4.4.2 Installation of backrest	22
4.4.3 Installation of bidet	23
5. Troubleshooting	23
6. Cleaning	24
6.1 Preapproved cleaning products	24
7. Maintenance	24
7.1 Periodic maintenance	24
7.2 Calibration of actuator.....	24
7.3 Maintenance of pipes and wiring	25
8. Component parts list	25
9. Environmental protection	25
10. Electromagnetic compatibility	26
10.1 Suitable Environments	26
10.2 Adjacent and stacked use.....	26
10.3 Cables	26
10.4 RF portable equipment	26
11. Accident reporting	26

1. Symbols used in this manual

Warning! Indication of potentially hazardous situation. If not avoided, it can result in serious injury or death.	
Caution! Indication of potentially hazardous situation which may result in minor or moderate injury. It may also be used to alert against unsafe practices.	
Notification! This symbol is used to notify correct use and handling of the product.	

2. General safety

	<p>This manual must be read and understood before use and installation. Always keep this manual in close proximity of the product.</p> <p>The use, installation and service of this product must be in compliance with this manual to avoid accidents and serious personal injury.</p> <p>Never use or handle this product in other ways specified in this manual as it can result in personal safety hazards and/or cause damage to the product.</p> <p>Persons installing and/or using this product either as operator or user should have the necessary safety information and access to this manual.</p> <p>If the supply cord is damaged, it must be replaced by the manufacturer, its service agent or similarly qualified designated persons in order to avoid a hazard.</p>
---	---



Do not perform repairs, disassembly or assembly operations, add-ons, re-adjustments or modification of the product beyond what is described in this manual. These must be carried out by Ropox or Ropox authorized personnel. Do not perform service while in use.

This appliance can be used by children aged from 8 years and above and persons with reduced physical, sensory or mental capabilities or lack of experience and knowledge if they have been given supervision or instruction concerning use of the appliance in a safe way and understand the hazards involved. Children shall not play with the appliance. Cleaning and user maintenance shall not be made by children.

Do not use the product if it has defects or have become damaged before being repaired or replaced.
If the control box makes unusual noise or smells, switch off the mains voltage immediately.

Take care that the cables are not damaged.

Unplug the mains cable on mobile equipment before it is moved.

The products must only be used in an environment that corresponds to their IP protection.



The information in this manual is based on correct installation in accordance with installation instructions for this product.

Ropox cannot be held liable if the product is used in any way that differs from stated in this manual and/or installation instruction.

Ropox reserve the right to amend this manual and reference documents without prior notice.

2.1 Product Unit label

ROPOX WEB.: www.ropox.dk
 Ropox A/S,
 Ringstedgade 221, DK-4700 Naestved
 TLF: +45 5575 0500, E-mail: Info@ropox.dk

Duty cycle max. 10% Transport & storage



2022-08
 REF 40-45027-1 SN N43-XXXX
Toiletlifter IP X6
 U In: 100-240V ~ 50/60 H U In: Max. 2,0 A
 Toilet Lifter Electric
 Height adjustment 40-65 cm
 Max load: 400 kg Mass of product: 34 kg

05707581000706N43-XXXX



	This product is UKCA-marked in accordance with: UK SI 2002 No. 618 - <i>The Medical Devices Regulations 2002</i> , and its amendments UK SI 2008 No. 1597 - <i>The Supply of Machinery (Safety) Regulations 2008</i> , and its amendments
	This product is CE-marked in accordance with: European Medical Device Regulation (EU)2017/745 Council Directive 2006/42/EC on machinery Council Directive 2011/65/EU, RoHS
	Manufacturer name and address
	Date of production
	Stock number
	Serial number
	Operating interval of electrically operated equipment. The use of electrical height adjustable equipment can run at maximum 2 minutes, followed by an 18-minute break.
	Type B applied part. The product complies with IEC 60601-1 requirements to provide protection against electric shock.
	Consult manual for important safety related information, warnings, and safety precautions.
	Class II, double isolated electrical components.
	Do not dispose as unsorted municipal waste. Product must be returned to a designated recycling station.
	Operating and storing temperatures may not exceed 5-40°C
	Consult the instructions for use

3. General requirements

3.1 Product information

Manufacturer	Ropox A/S Ringstedgade 221 DK-4700 Naestved +45 55 75 05 00 Info@ropox.com	UK Responsible Person	Qserve Group UK, Ltd 49 Greek Street, W1D 4EG London United Kingdom +44 740 885 936 3 info@qservegroup.com
Product models	Part number	Model	Configuration
	40-45027 40-46027	Toilet lifter Electric Toilet lifter Electric	Floor drain Wall drain
Expected service life	5 years		
MDR Class 2017/745	Class I		
Applied part classification 60601-1	Type B applied part		
MEE Class 60601-1	Class II		
Intended environments	This product is to be used only in: Professional Healthcare Environment Homecare Environment <i>The device is not intended for use in special environments as defined by IEC 60601-1-2</i>		
Maximum user weight according to ISO 17966:2016	400kg		
Power supply	100-240V ~50/60Hz		
I in	Max 2.0A		
Intermittence	2min use / 18min pause		
Height adjustment	400-650mm		
Speed of actuation	≈ 8mm/s		
IP rating	IPX6		
Ambient temperature range	-10 °C to +50 °C Transport and storage +5 °C to +40 °C Operation		
Relative humidity:	20% to 80% - non-condensing		
Materials in contact with patient	Components	Material description	
	Covers	ABS/PMMA plastic	

Accessories	
<i>Item nr.</i>	<i>Model</i>
40-45011	Height adjustable toiletsupports, Short straight
40-45012	Height adjustable toiletsupports, Long straight
40-45013	Height adjustable toiletsupports, Short Wave
40-45014	Height adjustable toiletsupports, Long Wave
40-45015	Height adjustable toiletsupports, Bariatric Short straight
40-45016	Height adjustable toiletsupports, Bariatric Long straight
40-45018	Height adjustable toiletsupports, Bariatric Long wave
40-45008	Clamps, for height adjustment without tools
40-45100	Backrest long (70cm Toilet)
40-45101	Backrest short (56cm Toilet)
40-44070	Wall hung toilet, 56cm
40-44071	Wall hung toilet, 70cm
40-44074	Toilet seat w/o lid
40-44075	Toilet seat w/ lid
40-44276	Svancare Bidet Elegant

3.2 Product description

The ROPOX toilet lifter electric can be set in heights ranging from 400-650mm by the use of the wireless handset. Height adjustment will meet different sitting height needs various patient heights.

3.3 Intended use

The ROPOX height adjustable toilet lifter is intended to be used in both homecare and professional healthcare environments. Adjusting the height will meet ergonomic demands emerging from various patient heights.

The toilet lifter is not intended for playing, or as a training device.

The ROPOX Toilet Lifter gives people with reduced mobility the possibility to extend their independence. It lowers and lifts the user to the best seated or standing position. Importantly it is straight-forward to set to the optimum height for both user and helper. It is a solution using modern welfare technology to help users become more self-reliant in their bathroom routines. The Toilet Lifter is an assistive aid which can support users to keep their privacy for as long as possible. The height adjustment has an adjustment range of 25 cm going from 40-65 cm.

3.4 Intended operator

The intended operator may include all that have read and understood this manual exempt kids.

3.5 Essential performance

The device does not have any function related to basic safety or essential performance. In case of loss or degradation of performance, the user can get off the toilet.

3.6 Non-clinical functions

Height adjusting offers better ergonomics to user and caretaker.

3.7 Clinical functions

This product does not offer clinical benefits for patients, when used as intended by the manufacturer.

3.8 Product dimensions

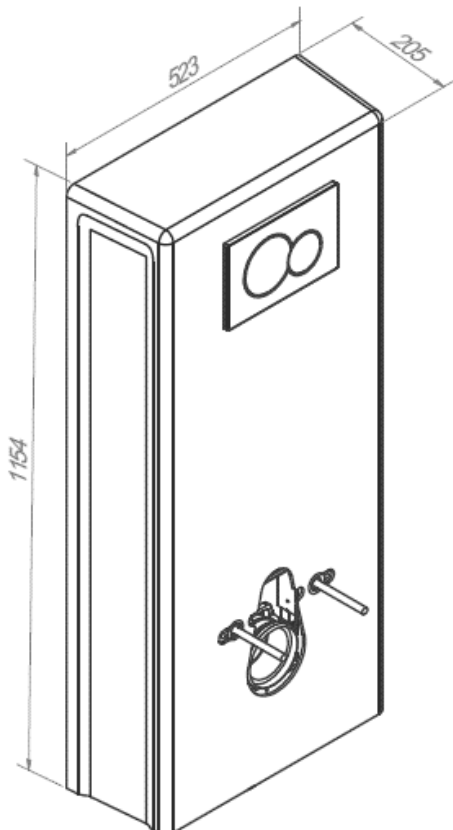

4. Instructions for use

4.1 Installation of product

The following instructions describe how to assemble and mount the toilet lifter, as well as optimal placement of water, electrical and drain, based on whether the toilet lifter with floor drain or wall drain has been purchased.

4.1.1 Installation interface for water and electrical socket

It is recommended to always place the water and electrical connections as shown below. In case of deviations, it's recommended to place the water and electrical sockets within the hatched areas.

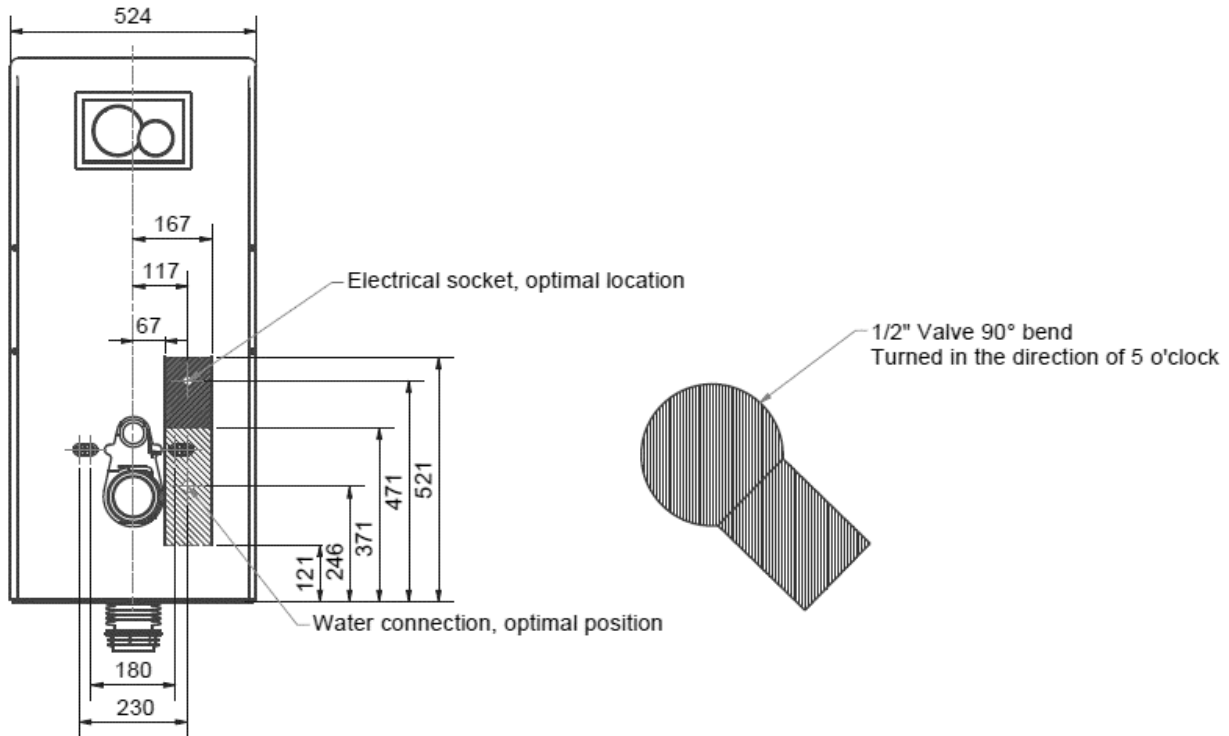

4.1.2 Installation interface for floor drain

For 40-45027

For the toilet lifter with a floor drain, it's recommended to place the drain within the hatched area, not deviating further than the shown tolerances. This ensures the best flushing. The drain can be raised up to 40mm, so as to live up to Säker Vatten.

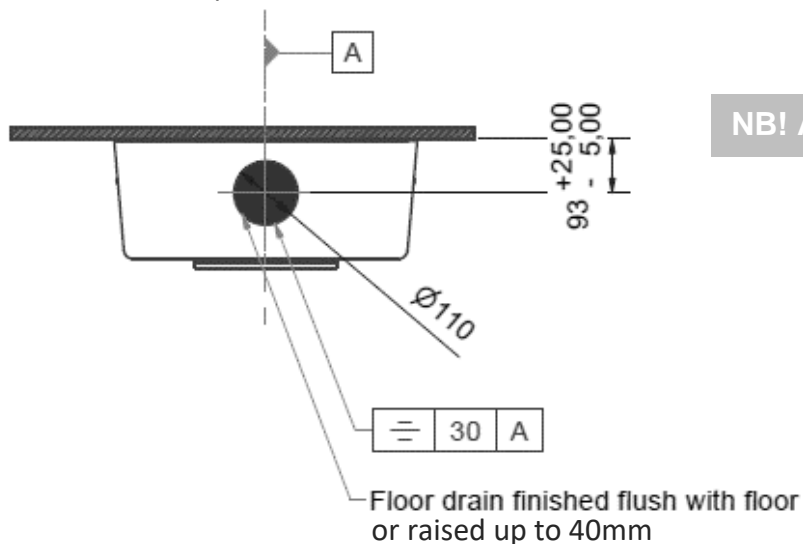





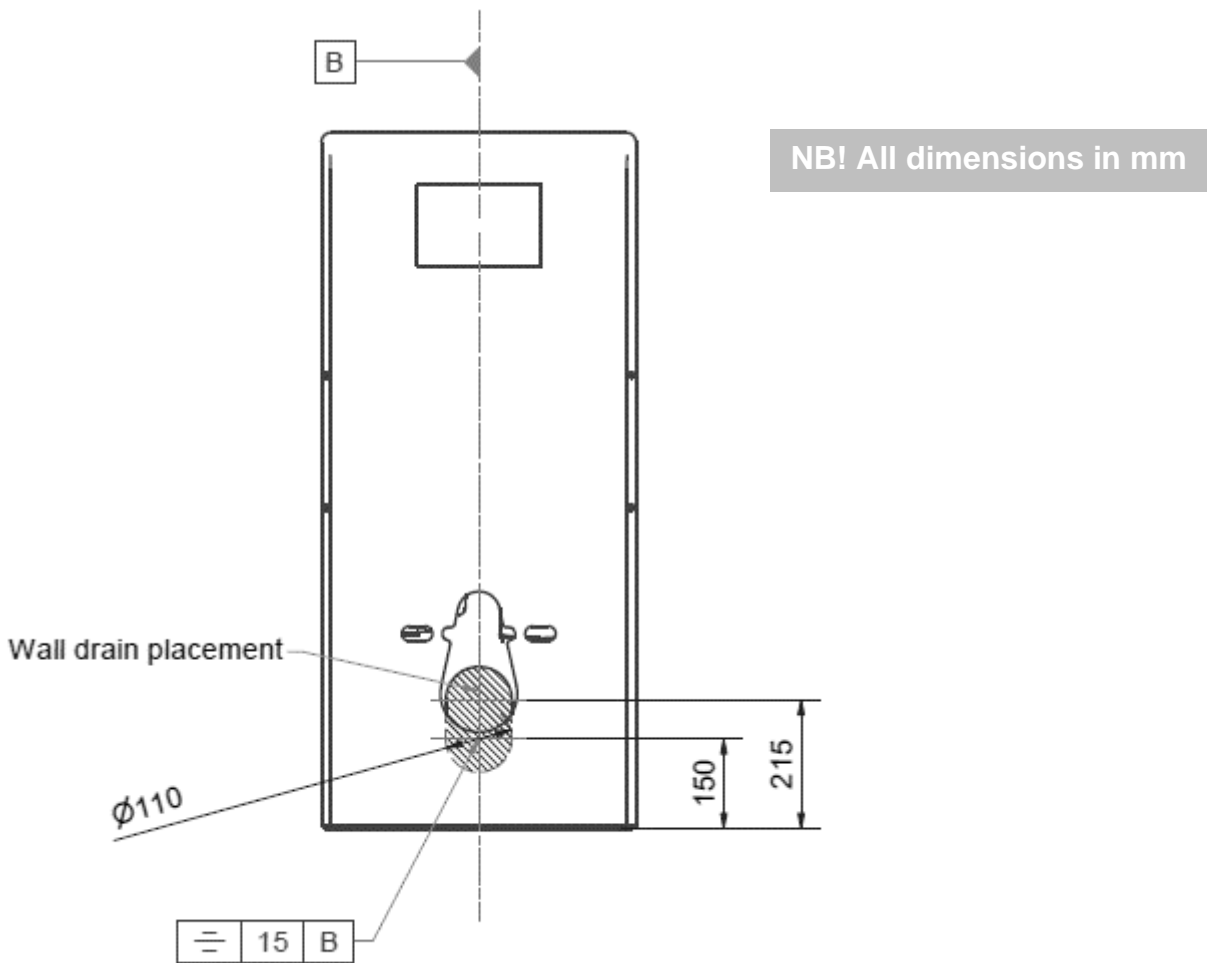

NB! All dimensions in mm

4.1.3 Installation interface for **wall drain**

For 40-46027

For the toilet lifter with a wall drain, it's recommended to place the drain within the hatched area, not deviating further than the shown tolerances. This ensures the best flushing.

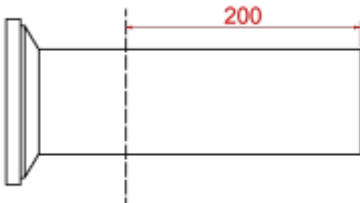

Ropox supplied toilets	Shortening of ferrule	Shortening of flush pipe
<p>40-44070</p> 		
<p>40-44071</p> 		

4.1.4 Construction

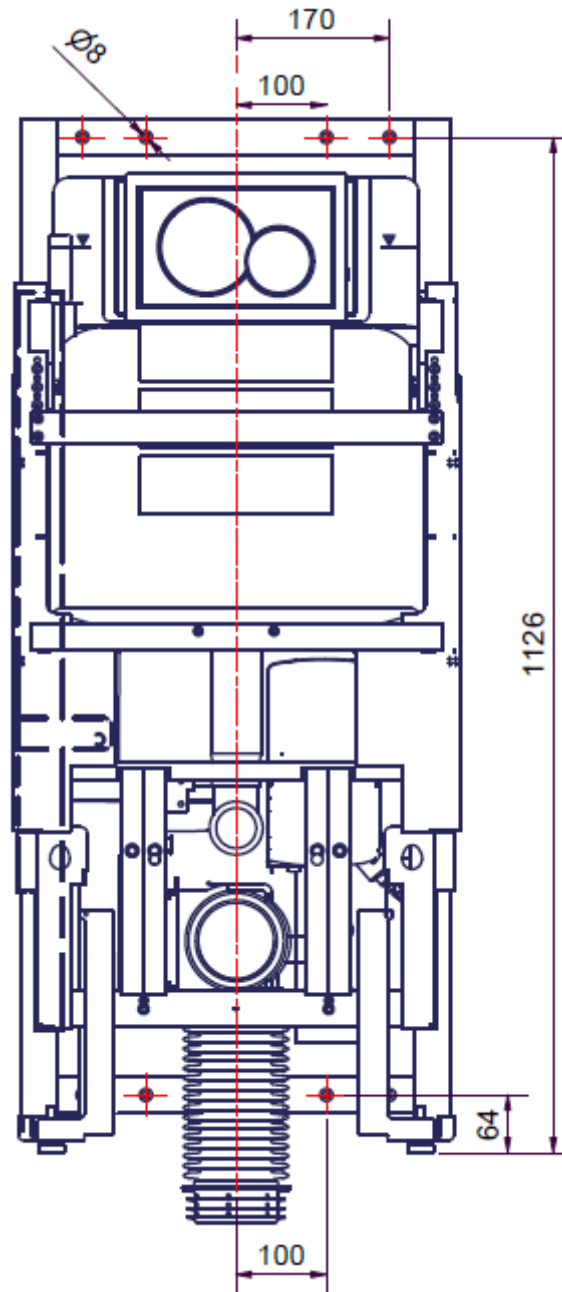

Note!

The toilet lifter is supplied with a set of 6 screws and rawplugs suitable for mounting in a concrete wall. The fitter should always consider the material, condition, and strength of the wall and use screws and rawplugs suitable for the specific wall type.



Caution!

Maximum pulling force per screw is 44kg, at 400kg max user weight according to ISO 17966: 2016

4.1.5 Mounting the product

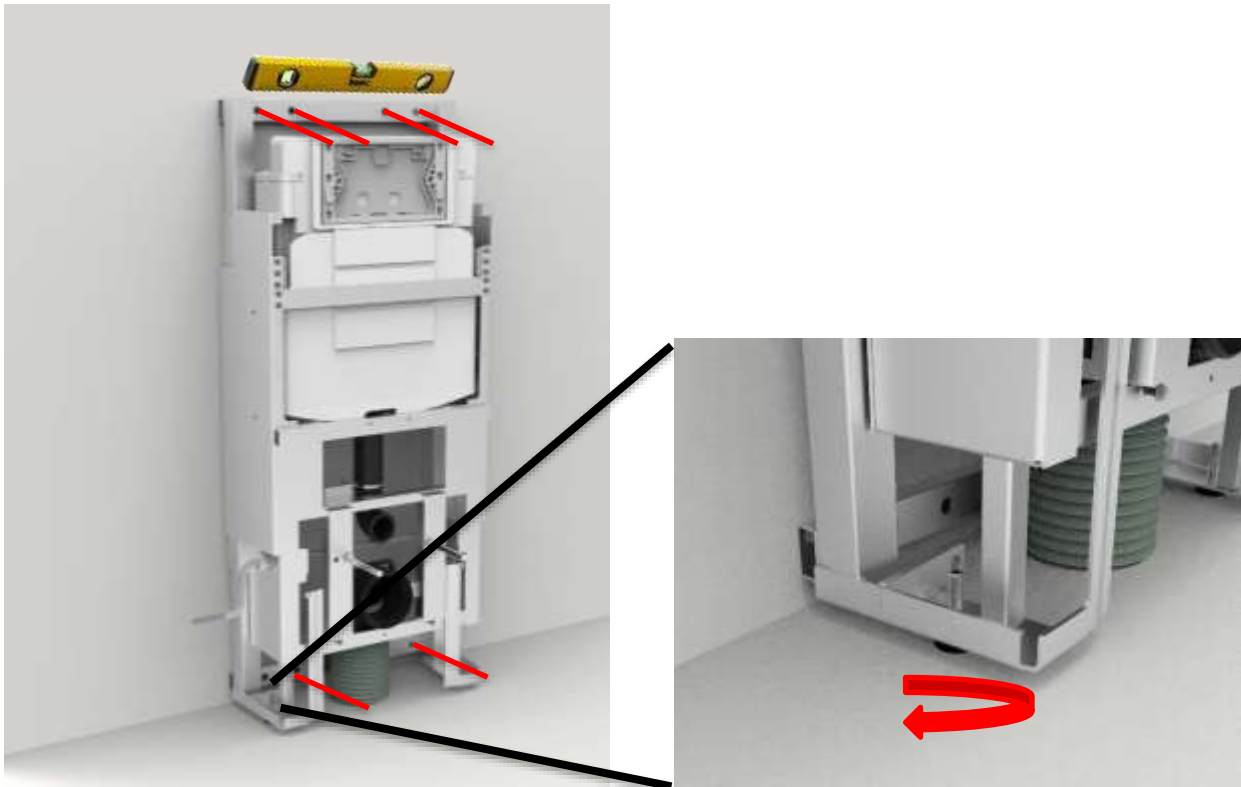

a. Line up frame with adjustment screws. Mark out 6 holes and drill holes for appropriate rawplugs. Ensure that the center of the bottom 2 holes is at least 64mm above the floor

b. Connect water hose on wall outlet and electric outlet before securing frame to the wall

c. Secure frame to wall

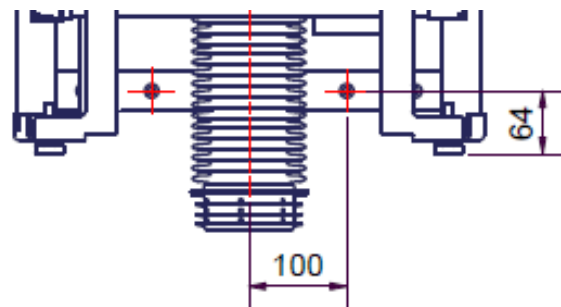

d1. For 40-45027

If drain is in **floor**, mount the drain bellow as instructed below. The examples given below to the left, are configurations that will work, but as a general rule, the installation interface in 4.1.2 should be followed.



Make sure the bellow is not twisted



Mount the bellow as shown below for correct flow

d2. For 40-46027

If drain is in **wall**, mount the drain bellow in wall drain, mount the accompanying brackets on the wall, so that the toilet flange is held in place



Make sure the bellow is not twisted

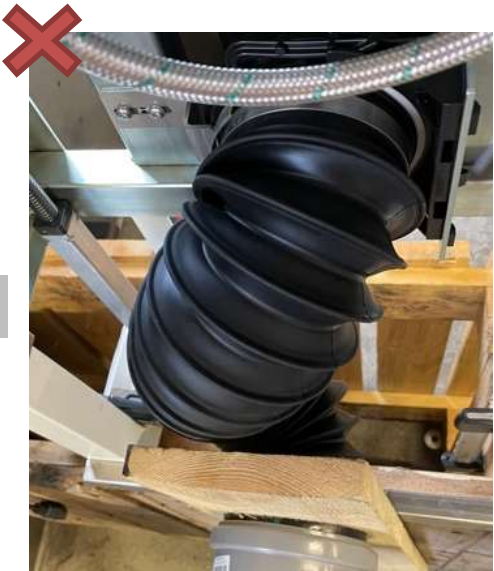

4.1.6 Pair the Bluetooth remote

Before continuing to mount the toilet lifter, it's important to test the functionality of its travel, by first pairing the Bluetooth remote to the lifter, and then doing a functionality test. This is done by following the steps listed below.

1. Stand within 2 meters of the toilet lifter, take the hand control, and face it away from the lifter
2. Hold the magnet key over its symbol, then hold down the "Down" button (at least 3 seconds), until the LED starts blinking
3. Release the "Down" button, remove the magnet key from the hand control, and move closer to the toilet lifter, until the buzzer increases in frequency
4. Press the "Down" button once. There should be two beeps, this confirms pairing

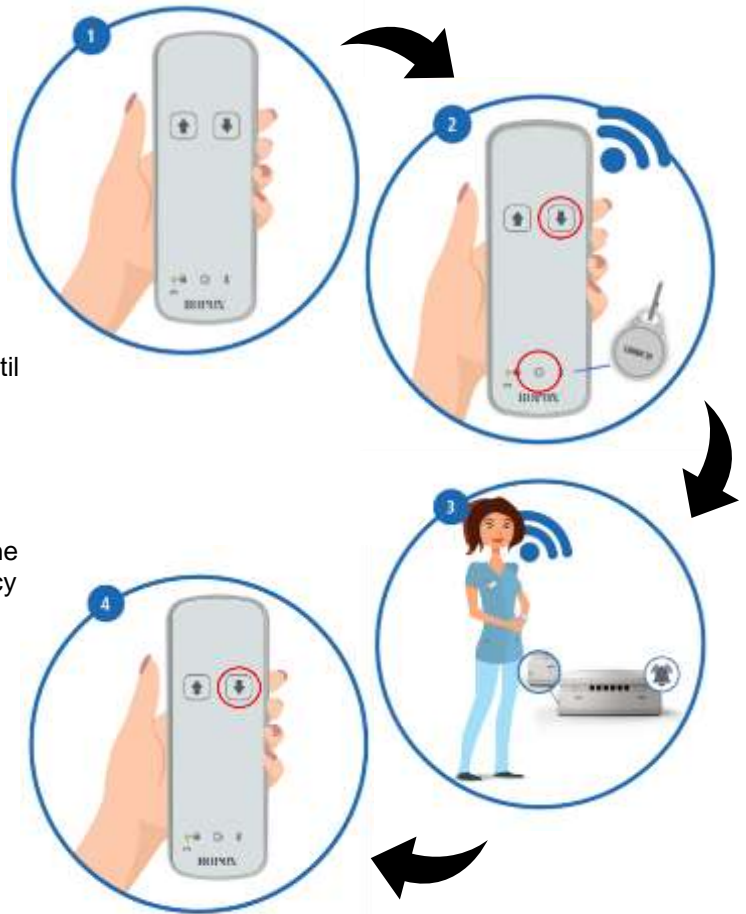

	<p>Note! When pairing is complete test product travel. Make sure all cables, water connection and drain connection travel freely. The electrical connection shall travel unhindered and may not get entangled in other installations.</p>
--	--

4.1.7 Unlock the handcontrol

The handcontrol will be unlocked when it is delivered, however, it's possible to lock it accidentally, preventing you from driving the lifter. This can occur due to power outages or by playing with the magnet key near the handcontrol. To unlock the handcontrol, follow the listed procedure:

1. Take the handcontrol, then hold the magnet key over its symbol
2. While the magnet key is in this position, press the "Down" button, then the "Up" button
3. If this doesn't solve it, follow the pairing procedure. Otherwise, it might not work due to low battery, or if the lifter is unplugged from the power

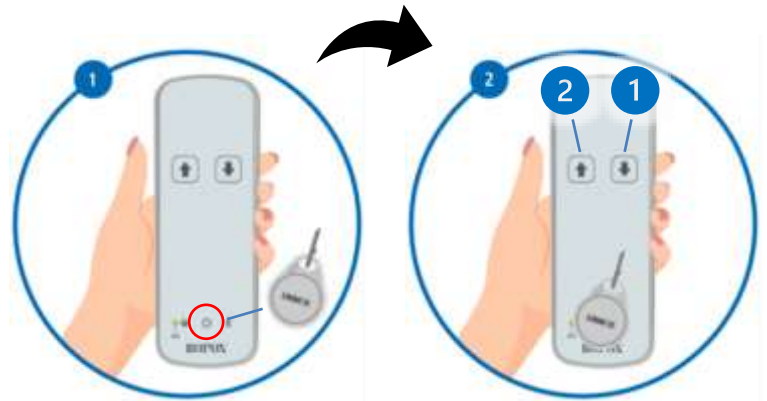

4.1.5 ... continued

e. Cut threaded rods to length and secure them in the frame

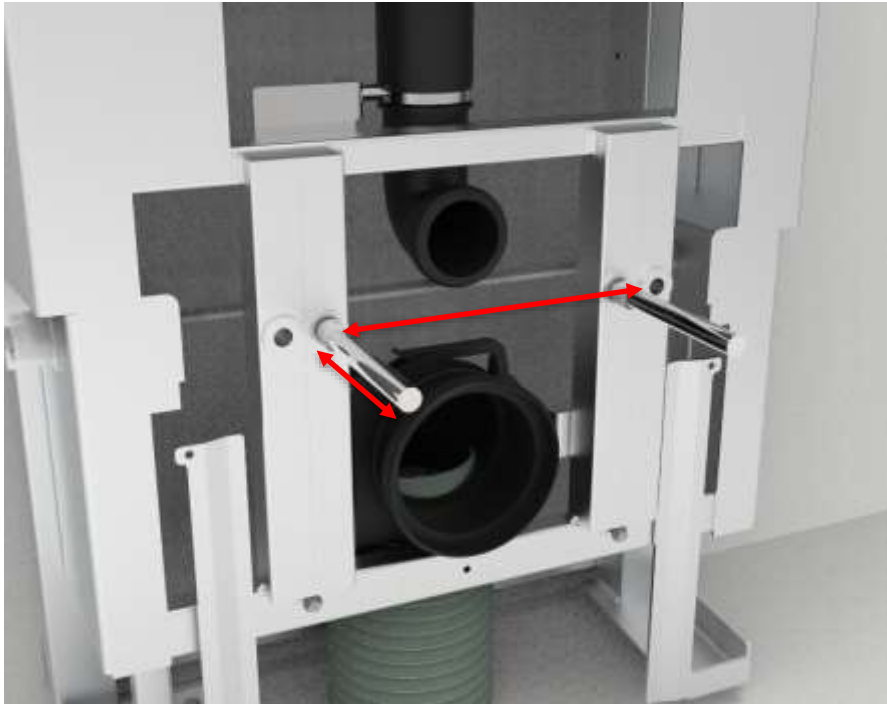

f. Mount inner cover 1 and 2

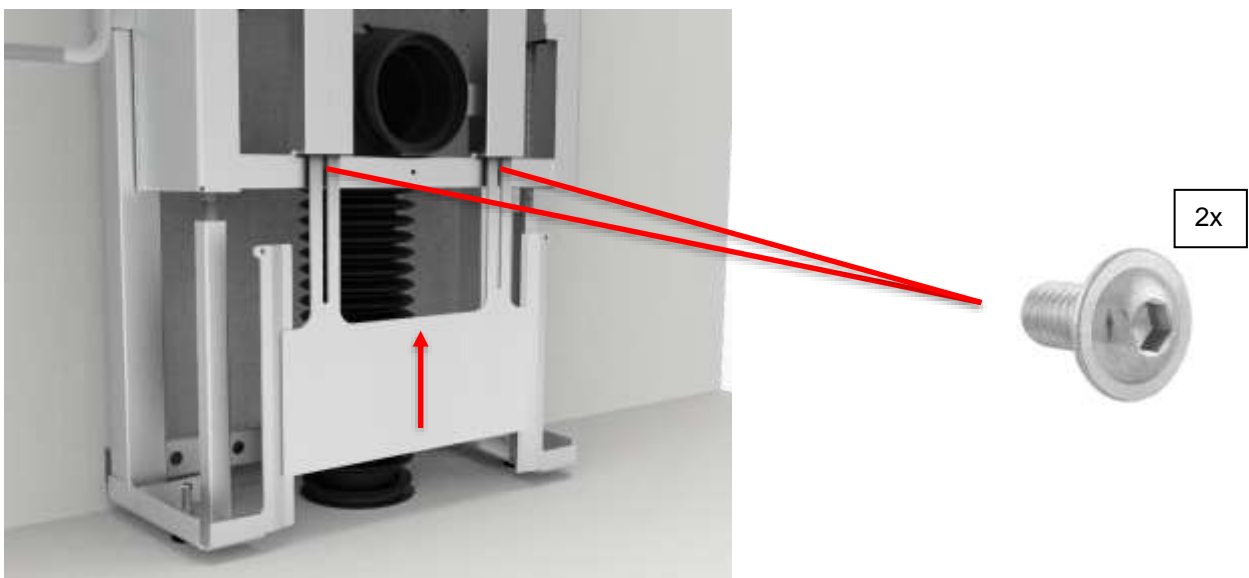

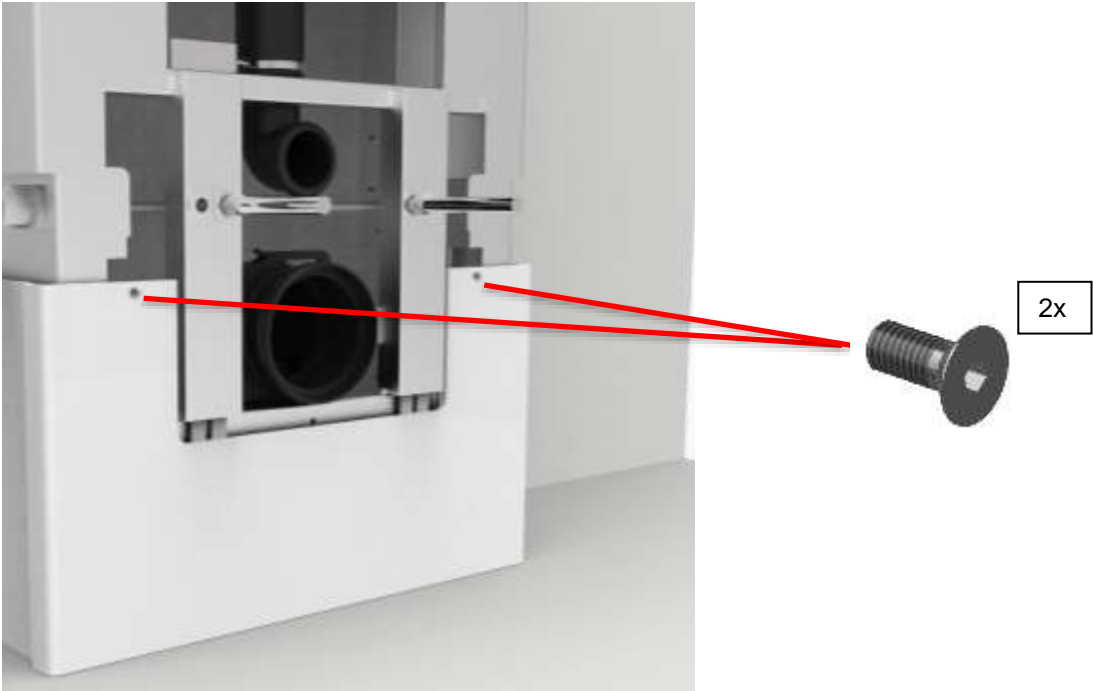

g. Mount outer cover



h. Shorten ferrule and flush pipe to length and mount them.



i. Mount the toilet and press pad.



j. Finish the installation by checking the following:



1. Rigidity test, sit on the toilet and check screw connections are firm.
2. Check that full travel of the product goes unhindered.
3. Check flushing and leaks.

4.2 Operating the product

Operating the product is done by using the remote.



	Warning!
<p>The product should always be able to travel the full range of actuation without colliding with objects. Failing to do so will compromise the product stability. Special care should be taken in ensuring that no children or adults are sited under the product as severe injury from entrapment may occur.</p>	

4.3 Residual risks

Warning!	
	<p>Be aware that there may be no person or body parts under the toilet when it is driven down, as it is a crushing hazard.</p>
Caution!	
	<p>Do not place your hand/fingers between the wall and the movable cover, as you risk crushing your hand/fingers.</p>
Warning!	
	<p>In case of incorrect installation of plumbing parts, water leaks can occur on the floor, which may increase the risk of falling.</p>

4.4 Installation of accessories

4.4.1 Installation of height adjustable toilet support arms

- a.** Attach housing to the profile with 3x M6x12 and 1x M6x16. Use a locking nut on M6x16.



- b.** Make sure that the plastic cover is pressed as far onto the frame as possible. Mount 2x M6 buttonhead screws in the back holes on both sides. Leave 5mm of clearance between underside of screw head to the plastic cover.

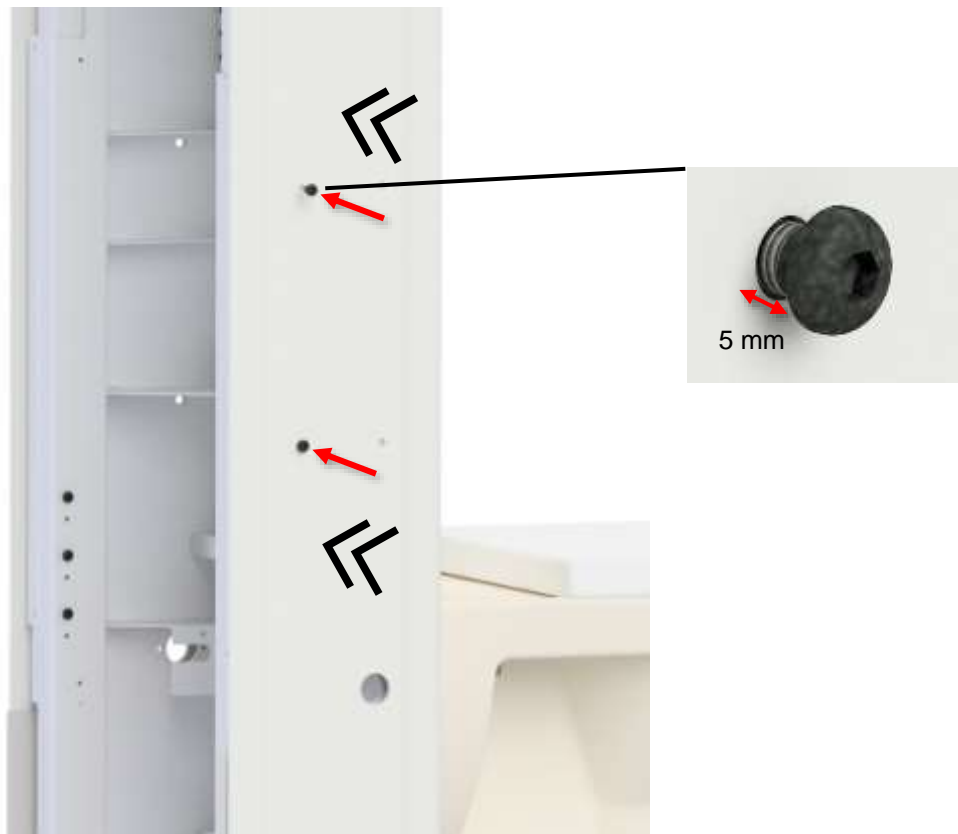

C. Slide the assembly onto the two screw heads and attach the assembly with the two M6x30 as shown.

If need be, the two M6x30 can be loosened, and the support arms can be adjusted in height to better fit the user. The screws must be fastened after adjustment.

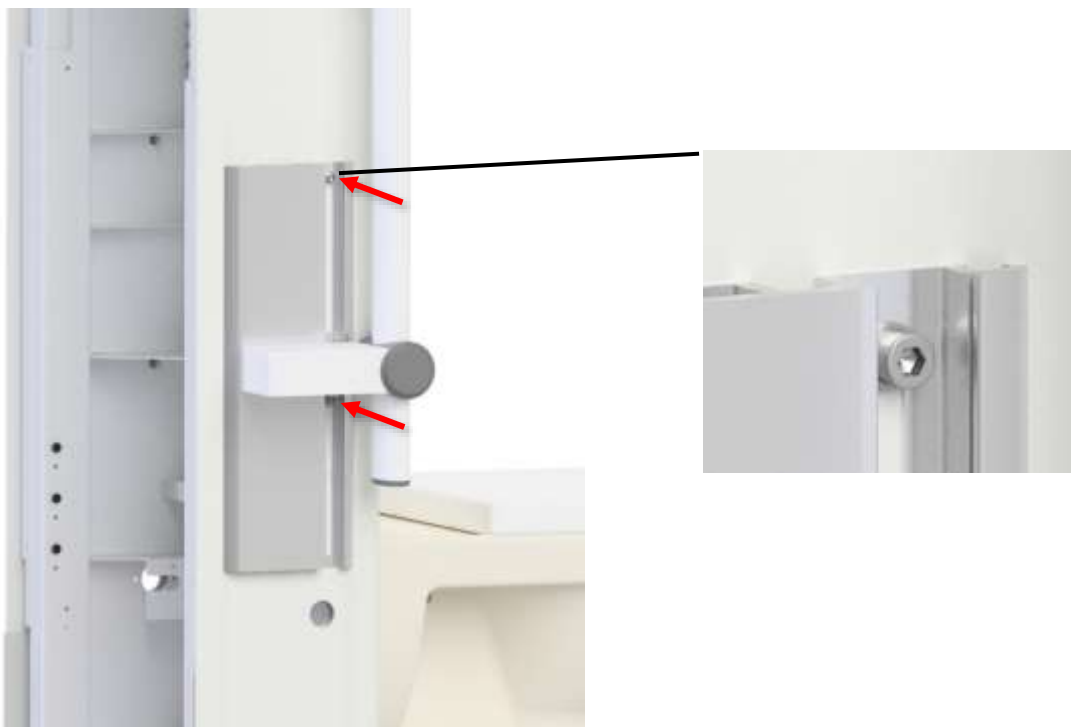
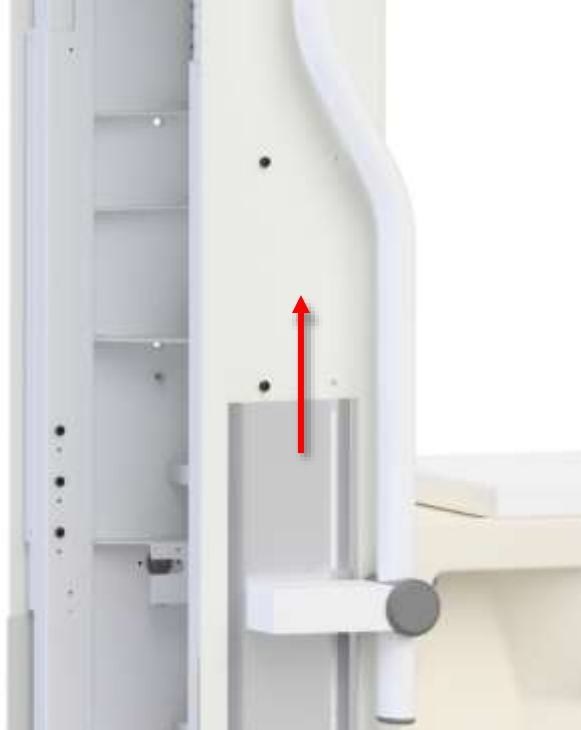

- d.** Test the toilet support arms in the horizontal direction. If they can twist significantly, dismount the assembly and leave <math><5\text{mm}</math> between the underside of the screw head to the plastic cover. There should be no clearance between the aluminum bracket and plastic cover. Adjust until the support arms are properly fastened.



- e.** Slide in the cover and end rubber caps.

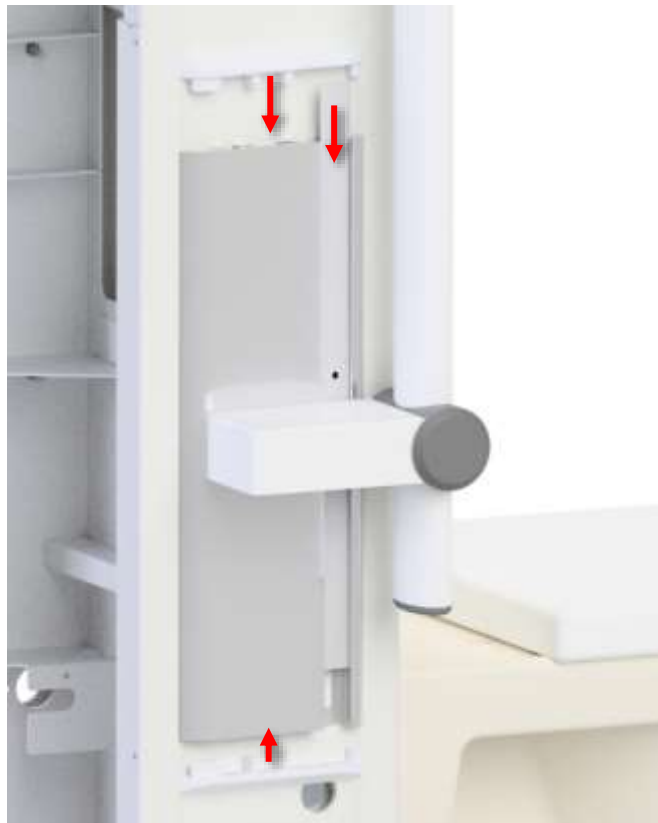

4.4.2 Installation of backrest

If Ropox Back Support long is ordered together with Ropox Toilet Lifter, there will be pre-drilled holes in the cover cap. If the back support is ordered later for subsequent mounting, new holes must be drilled. Please see the dimension drawing for the location of holes.

Two M5x16 are used.

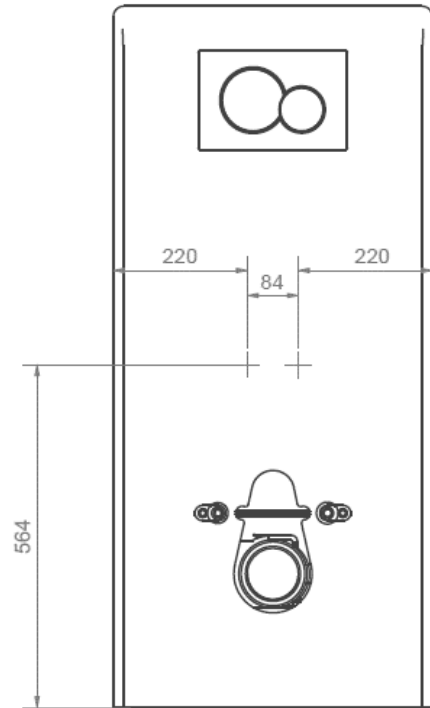

a.



b.

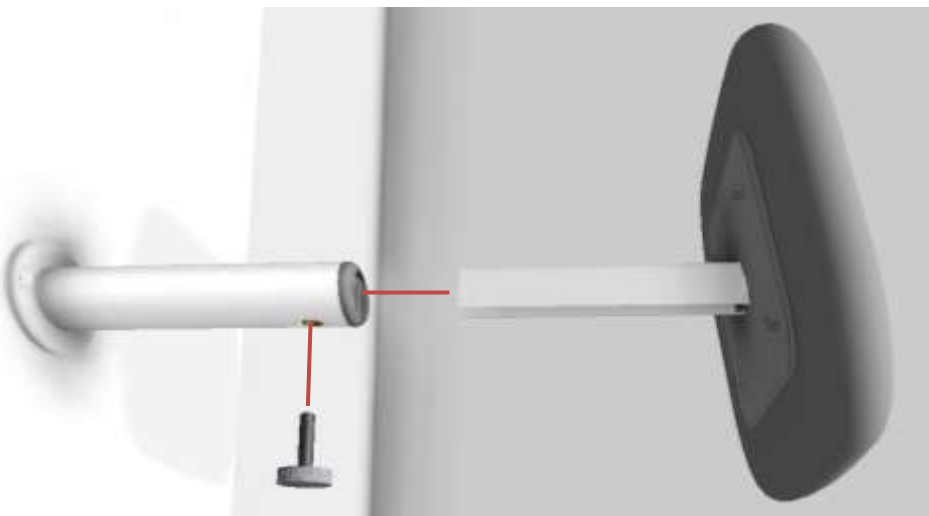

4.4.3 Installation of bidet

To mount SvanCare Bidet Elegant, see **TF 200.01.0025**.



5. Troubleshooting

Product doesn't work	Check pairing of remote Check that all wires are pressed into the sockets
Product stopped working	Check batteries of remote Check if the power is plugged in
Handcontrol doesn't work	Check battery power Follow the unlocking procedure Follow the pairing procedure

6. Cleaning

Cleaning can be done with lukewarm water and a suitable all-purpose cleaning agent. Use a cloth or soft sponge to wash the product. Dry the product with a wrung cloth.

	<p>Note!</p> <p>Do not use cleaning agents containing abrasive e.g., scouring powder, steel wool, scouring sponge.</p> <p>This product is not designed to be sterilized. Autoclaving and sterilization beyond normal means may change the product safety and function.</p>
---	---

6.1 Preapproved cleaning products

Tradename	Solution
Acticlor plus	1000ppm
S90 sanirens	1-3% peracid
FUTUR, Alkalic	1% Solution [pH 9,5]

7. Maintenance

	<p>Note!</p> <p>Failing to comply with periodic maintenance may result in degradation of the product function and safety.</p>
---	--

7.1 Periodic maintenance

Component	Maintenance activity	Maintenance interval	Registration date of maintenance
Geberit Sigma 12 cistern	Descaling / change of worn components	6-12 months dependent on calcium content in water	

7.2 Calibration of actuator

Actuator(s) are aligned and calibrated from the factory. In case they need calibration to run simultaneously use the following procedure.

Press and hold both UP and DOWN on the remote (▲▼) until the unit has beeped approx. ten times. Then adjust the product to the bottom position by pressing DOWN on the remote until movement of both columns are in the lowest possible position.

7.3 Maintenance of pipes and wiring

If need be, it's possible to open the lower cover plate, by taking the lifter to the highest position, and sliding the service hatch up. Never attempt to service the toilet lifter while actuating it.



8. Component parts list



Note!

Ropox will make part lists and circuit diagrams available for extraordinary maintenance and repair beyond what is described in this manual. Repair beyond what is described in this manual may only be done by Ropox designated service personnel.

9. Environmental protection

The product is not intended to be disposed as municipal waste. Proper disassembly, sorting and disposal of components must be done by waste disposal professionals.



Part	Disposal recommendation
Frame	Steel
Cistern	Hard plastic Polystyrene
Covers	Hard plastic (ABS/PMMA)
Height adjustable toilet support arms	Steel

10. Electromagnetic compatibility

10.1 Suitable Environments

The device is suitable for use at home, at daycare centers, at day centers for people with physical or mental disabilities or at hospitals except near active HF surgical equipment and the RF shielded room of a medical electrical system for magnetic resonance imaging, where the intensity of electromagnetic disturbances is high.

10.2 Adjacent and stacked use

	<p>Warning!</p> <p>Use of this equipment adjacent to or stacked with other equipment should be avoided, as it could result in improper operation. If such use is necessary, this equipment and the other equipment should be observed to verify that they are operating normally.</p>
---	--

10.3 Cables

Cable component	Length
Power cable	1,2m
Remote spiral cable	Wireless

	<p>Warning!</p> <p>Use of accessories, transducers, and cables other than those specified or provided by the manufacturer of this could result in increased electromagnetic emissions or decreased electromagnetic immunity of this equipment and result in improper operation.</p>
--	--

10.4 RF portable equipment

	<p>Warning!</p> <p>Portable RF communications equipment (including peripherals such as antenna cables and external antennas) should be used no closer than 30 cm (12 inches) to any part of the device, including cables specified by the manufacturer. Otherwise, degradation of the performance of this equipment could occur.</p>
---	---

11. Accident reporting

The manufacturer of this product recommends any accident with this product that meets all the following criteria reported to the appropriate authority as well as to the manufacturer.

1. There has been or could have been an accident
2. The medical device is considered to be a contributing factor to the case, and
3. The event resulted or could have resulted in one of the following outcomes:
 - Death - a patient, a user or a third party's death
 - A serious deterioration of a patient's health, a user's health or a third party's health status in the form of:
 - a. Life-threatening disease
 - b. Lasting damage or injury
 - c. Necessary medical or surgical treatment to divert life-threatening illness, permanent injury
 - d. Fetal death, fetal injury, or congenital abnormalities